



# **FastLink™ Network**

---

## **Operation and Installation Manual**

- C6570     Store and Forward Controller**
- C6571     Network Store and Forward Controller**
- C6571S    Service Store and Forward Controller**
- C6572     Network Central Station Interface**
- C6572S    Master Service Central Station Interface**
- C6573S    Service Central Station Interface**

## **Notice**

The material and instructions in this manual have been carefully checked for accuracy and are presumed to be reliable. However, Radionics, Inc. assumes no responsibility for inaccuracies and reserves the right to modify and revise this manual without notice.

It is our goal at Radionics to always supply accurate and reliable documentation. If a discrepancy is found in this documentation, please mail a photocopy of the corrected material to:

Radionics, Inc.  
c/o Technical Writing Department  
1800 Abbott Street  
Salinas, California 93901

## **FCC Notice**

This equipment has been tested and found to comply with the limits for a class A digital device, pursuant to part 15 of the FCC Rules. These limits are designed to provide reasonable protection against harmful interference when the equipment is operated in commercial environment. This equipment generates, uses and can radiate radio frequency energy and, if not installed and used in accordance with the instruction manual, may cause harmful interference to radio communications. Operation of this equipment in a residential area is likely to cause harmful interference in which case the user will be required to correct the interference at his own expense.

## Table of Content

<b>I. INTRODUCTION</b> .....	<b>4</b>
FastLink™ Network System Description.....	5
FastLink™ Store and Forward Unit .....	6
Physical Description .....	6
<b>II. INSTALLATION</b> .....	<b>8</b>
Mounting, connections and Power-Up.....	8
Store and Forward audio input (receive) setup.....	9
Store and Forward audio output (transmit) setup .....	11
Store and Forward units Inputs and Outputs.....	11
<b>III. PROGRAMMING</b> .....	<b>12</b>
<b>IV. C6572, C6572S and C6573S FEATURES</b> .....	<b>12</b>
Dynamic Event Display LCD.....	12
Keypad functions .....	14
Menu Structure .....	15
Program Menu Options .....	16
Printer Outputs .....	18
<b>V. DEFINITIONS</b> .....	<b>21</b>
<b>VI. TROUBLESHOOTING and SPECIFICATIONS</b> .....	<b>22</b>

## Figures and Tables

FastLink™ Network System Description.....	4
C6570, C6571 and C6571S Back Panel .....	6
C6572, C6572S and C6573S Back Panel .....	6
FastLink™ Store and Forward Back Panel Features.....	7
C6570, C6571 and C6571S Front Panel .....	7
C6572, C6572S and C6573S Front Panel.....	7
FastLink™ Store and Forward Connections .....	8
LED Display .....	9
Repeater Logic Board (Receive Audio and VCO).....	9
Repeater Logic Board (Transmit Audio) .....	11
J4 Radio 1 (End-Units).....	11
J5 Radio 2 (Network) .....	11
Liquid Crystal Display .....	12
Liquid Crystal Display and Message Priority.....	13
Front Panel Keypad Functions.....	14
Menu Structure .....	15
Sample Printer Page.....	19
Radionics D6500 Messages .....	19
COM-1 Output Messages .....	19
RS232 Cable, FastLink™ Store and Forward COM-1 to PC .....	20
Troubleshooting Chart .....	23
Specifications.....	25

## I. INTRODUCTION

### FastLink™ Network System Description

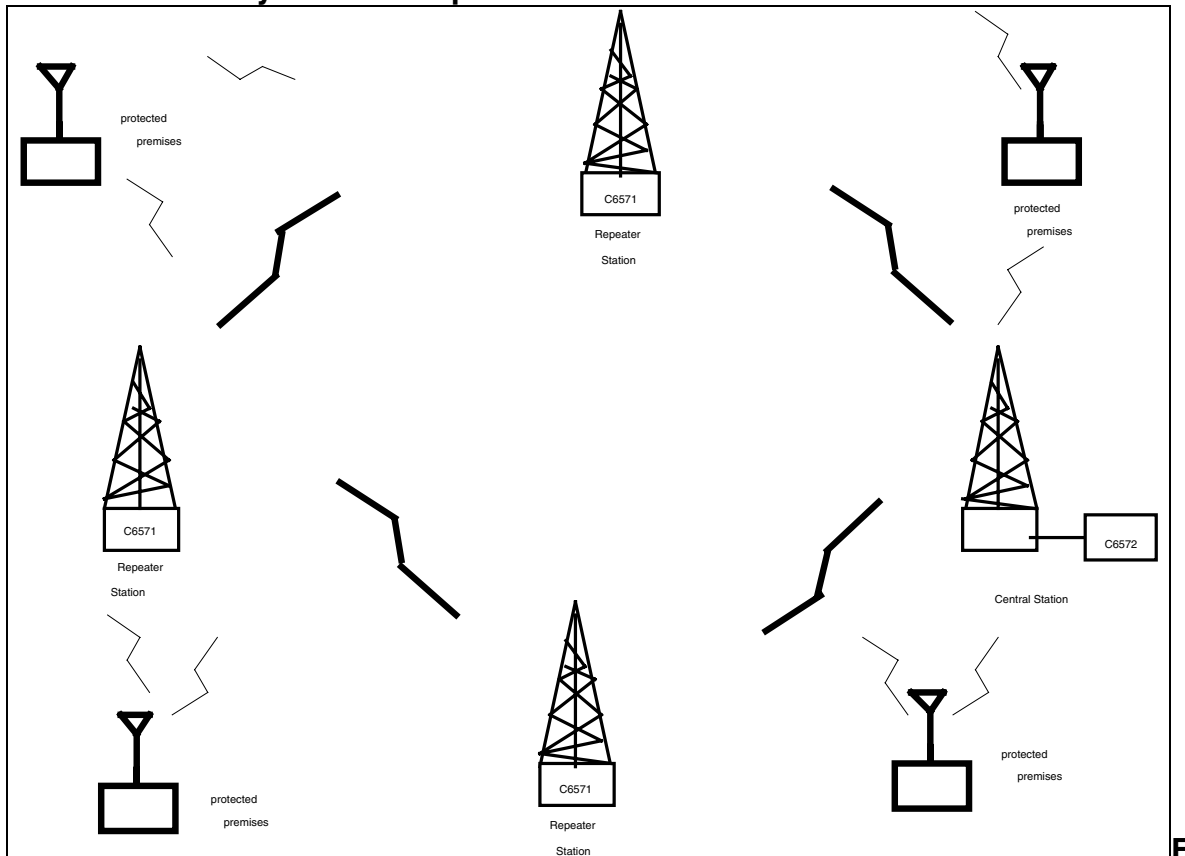

**rror! Switch argument not specified.**

Normally alarm signals are relayed by a digital control communicator via a telephone line to a digital receiver located at a central station. The signal is then processed by the digital receiver and sent to an automated software system running on a computer.

In a basic Radionics FastLink™ radio system alarm messages are also sent via radio broadcasting to a radio receiver located at the central station. The radio receiver outputs the alarm messages to a Radio Line card located in the central station digital receiver for normal processing.

Radionics FastLink™ Store and Forward units can be used to configure simple radio repeaters, complex radio systems, or combinations of both. Systems can provide secondary and alternative means of transmitting alarm messages from protected premises to the central stations using radio broadcasting and digital microcomputer technology. The FastLink™ Store and Forward unit is a data processor used to accept, decode and process messages from protected premises for re-encoding and re-transmission employing the Radionics FastLink™ long-range radio message format.

FastLink™ Radio systems can be configured into a Network interconnecting up to 254 FastLink™ Store and Forward units. Each Store and Forward unit must be able to communicate with at least one other Store and Forward unit in order to form a network. The messages transmitted by protected premises should be received by at least one, and preferably more than one FastLink™ Store and Forward unit. The ultimate objective of a radio network is to provide redundant coverage and extended range with high reliability and efficiency for processing alarm signals to the central station.

## **The FastLink™ Store and Forward system consists of:**

**1. End-Units:** a FastLink™ C601 Encoder and a FastLink™ C472 Radio Transmitter installed at a protected premises interconnected to a local alarm panel transmitting on one frequency (F1).

**2a. Simple Store and Forward Repeater stations:** a C6570 FastLink™ Store and Forward Repeater Interface interconnecting a radio receiver and radio transmitter. Normally, the station receives and transmits on one radio frequency (F1), but two radio frequencies may also be used, one for receiving (F1) and the second for transmitting (F2).

**2b. Network Store and Forward Repeater stations:** a C6571 or C6571S FastLink™ Store and Forward Controller interfacing two radio receivers and one radio transmitter. One radio frequency (F1) listens to End-Units and a second (F2) radio frequency is used to receive and transmit between other Network Store and Forward Repeater stations.

**3. Master Central Station Interface station:** a C6572 or C6572S FastLink™ Central Station Interface interconnecting a radio receiver and radio transmitter with a C6565 Terminator Card and a C6560 RF Line Card installed in a D6500 Radionics Central Station Receiver. One radio frequency (F1) listens to End-Units and a second (F2) radio frequency is used to receive and transmit between other Network Store and Forward Repeater stations. The primary function of this station is control of the radio network and termination to the central station.

**4. Central Station Service Interface station:** a C6573S FastLink™ Service Central Station Interface interconnecting a radio receiver and radio transmitter with a C6565 Terminator Card and a C6560 RF Line Card installed in a D6500 Radionics Central Station Receiver. One radio frequency (F1) listens to End-Units and a second (F2) radio frequency is use to receive and transmit between other Network Store and Forward Repeater stations. The primary function of this station is termination to the central station.

### **FastLink™ Store & Forward Unit**

A FastLink™ Store and Forward unit can processes alarm, restoral, and trouble messages received from End-Units, radio repeaters, and other Store and Forward units. It decodes, re-encodes and relays messages in accordance with custom factory pre-programming based on the dealer's intended RF system configuration. A Store and Forward unit is capable of functioning as a simple stand alone unit in a network configuration, or in a combination of both, buffering messages until acknowledgment from other Store and Forward units. Each Store and Forward unit can be programmed to process messages to and from as many as sixteen other Store and Forward units.

## FastLink™ Store & Forward unit models:

- C6570** Store & Forward Controller.
- C6571** Network Store & Forward Controller.
- C6571S** Service Store & Forward Controller.
- C6572** Network Central Station Interface.
- C6572S** Master Service Central Station Interface.
- C6573S** Service Central Station Interface.

### Physical Description

The C6572, C6572S and C6573S FastLink™ Central Station Interface unit is enclosed in a standard 19 inch mountable metal enclosure. The front panel on the C6572, C672S and C6573S consists of an alpha numeric liquid crystal display (LCD) and a keypad consisting of eight push-button switches (keys). The LCD display is for displaying real time events, recorded events, and programming menu and communications port functions. The eight push-buttons are used to access and program LCD display functions.

### C6570/C6571/C6571S BACK PANEL



### C6572/C6572S/C6573S BACK PANEL

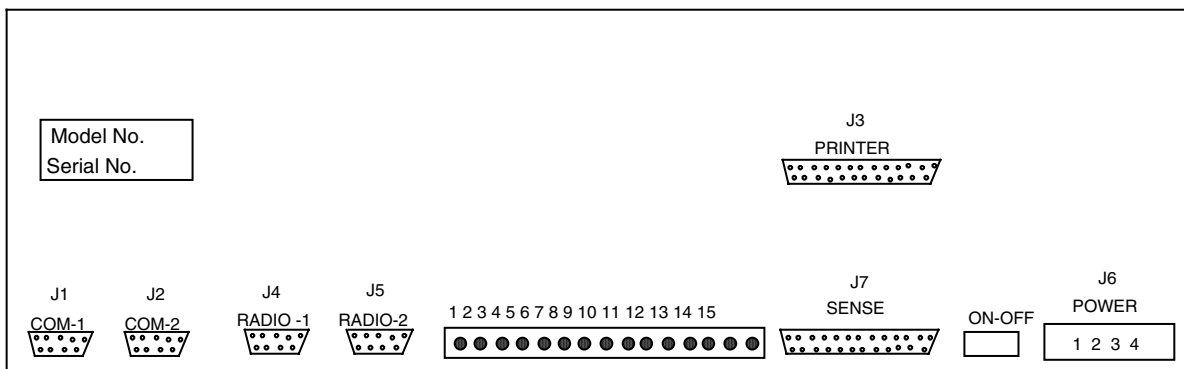

### FastLink™ Store and Forward Back Panel Features

LABEL	DESCRIPTION	FUNCTION
J1 - COM 1	DB-9(M)	Serial data output
J2 - COM 2	DB-9(M)	Programming
J4 - RADIO 1	DB-9(F)	Radio Receiver audio, End-Unit input
J5 - RADIO 2	DB-9(F)	Radio Transceiver audio, Network input and output
1--15	LED's	Real time system indications
J7 - SENSE	DB-25(F)	Factory use
OFF - ON	Slide Switch	Power Off/On
J6 - POWER	4 Pins(F)	Power input
J3 - PRINTER	DB-25(F)	Printer output (C6572/C6572S/C6573S only)

### C6570/C6571/C6571S FRONT PANEL

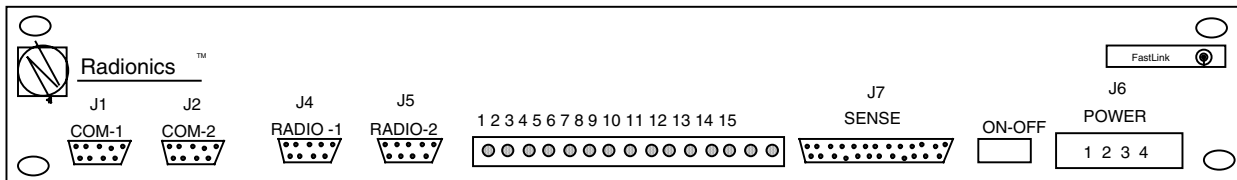

### C6572/C6572S/C6573S FRONT PANEL

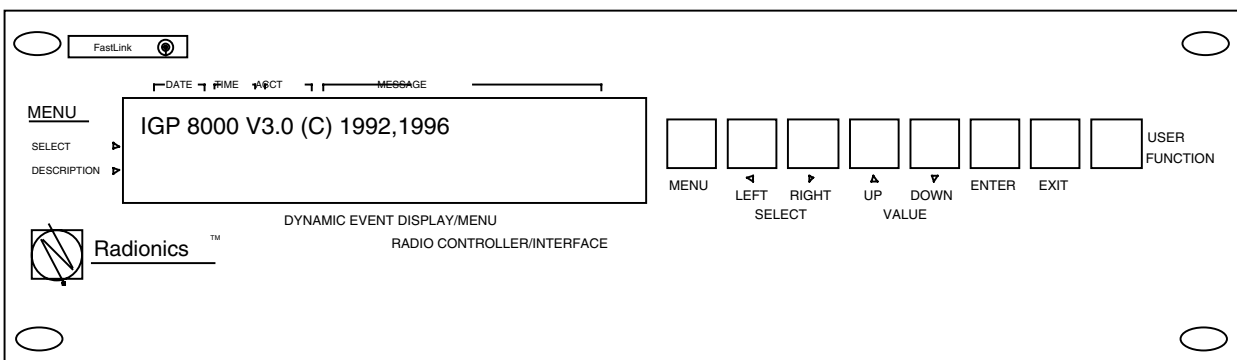

## II. INSTALLATION

### Mounting, connections, and power-up.

Mount and secure the FastLink™ Store and Forward unit.

Make the appropriate connections to the FastLink™ Store and Forward unit in accordance with the following table.

**FastLink™ Store and Forward Connections**

<b>STORE and FORWARD</b>	<b>RADIO</b>	<b>OTHER</b>
J4-RADIO 1, pin 3	Receive audio	
J4-RADIO 1, pin 6	Common (Ground)	
J5-RADIO 2, pin 1	Transmit audio	C6565, pin 1
J5-RADIO 2, pin 3	Receive audio	
J5-RADIO 2, pin 5	Push-to-talk (PTT=low)	
J5-RADIO 2, pin 6	Common (Ground)	C6565, pin 6
J6-POWER, RED & RED	+ DC	Power Supply
J6-POWER, BLACK	DC Common (Ground)	Power Supply

Turn "ON" the power supply and the Store and Forward unit. Observe the LED panel for proper operation:

**LED 12 (RED) = OFF** - external +12V = OK

**LED 13 (GREEN) = ON** - internal + 5V = OK

**LED 14 (GREEN) = ON** - internal -12V = OK

**LED 15 (GREEN) = ON** - external +12 =OK



### LED Display

LED	COLO R	FUNCTION
1	Red	Flashing = TX data via COM-1
2	Red	Flashing = RX data via COM-1
3	Red	Flashing = TX data via COM-2
4	Red	Flashing = RX data via COM-2
5	Red	(Factory use.)
6	Red	(Factory use.)
7	Red	Flashing = message received via RADIO-2
8	Green	Flashing = message transmitted via RADIO-2

LED	COLOR	FUNCTION
9	Red	Flashing = message received via RADIO-1
10	Green	Flashing = message transmitted via RADIO-1
11	Red	COM CPU = ON = OK
12	Red	OFF = External +12V ON = Lost program Flashing = External AC
13	Green	Internal +5V = ON
14	Green	Internal -12V = ON
15	Green	External +12 = ON

### STORE AND FORWARD AUDIO INPUT (RECEIVE) SETUP

The following adjustments have been set at the factory and information is provided here in the event re-adjustment is required. The top cover of the FastLink™ Store and Forward unit must be removed in order to perform the adjustments. The cover is secured by screws. C6572, C6572S and C6573S Store and Forward units have a second printed circuit assembly which must be carefully moved in order to gain access to the Repeater Logic Board. Five screws secure the top board to the Repeater Logic Board.

**Radio 2 Audio Output to transmitter adjustment is required at time of installation.**

#### RADIO 1 receiver audio input and VCO adjustments:

1. Connect an Audio Generator source set for a 1200Hz sinewave output between 450mV--500mV as measured on a DVM set to measure AC to J4 pin 3 and pin 6 (ground) of the Store and Forward unit (Repeater Logic Board).

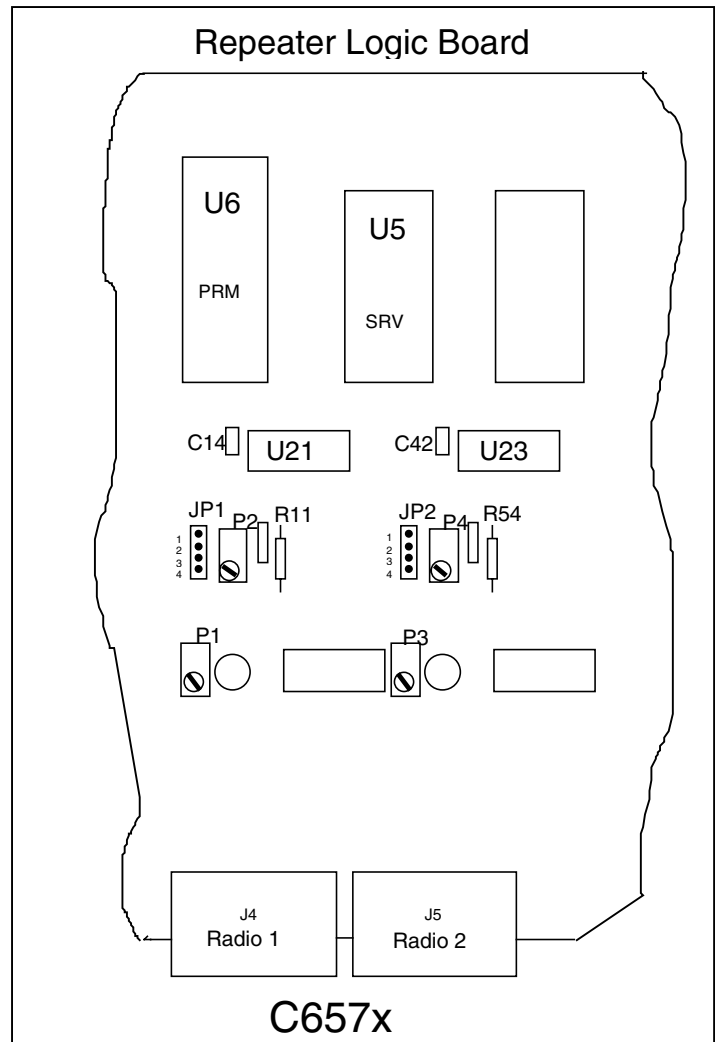

2. Connect a DVM set to measure AC between jumpers JP1-1 and JP1-4 (ground) of the Store and Forward Repeater Logic Board.
3. Turn potentiometer (pot) P1 fully counter-clockwise (CCW), the DVM reading will be about 50mV less than step 1.
4. Connect a DVM set to measure AC between jumpers JP1-3 and JP1-4 (ground) of Store and Forward Repeater Logic Board.
5. Turn pot P2 on the Store and Forward Repeater Logic Board for a minimum reading (<70mV).
6. Remove the J4 Audio Generator source, and connect the Radio Receiver audio output to J4 pin 3 and pin 6 (ground) of the Store and Forward unit (Repeater Logic Board). Adjust the Radio Receiver audio output to a level between 200mV--500mV. For higher levels proceed with the next step.
7. Reconnect a DVM set to measure AC between jumpers JP1-1 and JP1-4 (ground) of the Store and Forward Repeater Logic Board. Adjust pot P1 clockwise (CW) for a reading between 400mV--500mV. (Minimum recommend for decoding = 10mV).

**RADIO 2 receiver audio input and VCO adjustments:**

1. Connect an Audio Generator source set for a 1200Hz sinewave output between 450mV--500mV as measured on a DVM set to measure AC to J5 pin 3 and pin 6 (ground) of the Store and Forward unit (Repeater Logic Board).
2. Connect a DVM set to measure AC between jumpers JP2-1 and JP2-4 (ground) of the Store and Forward Repeater Logic Board.
3. Turn potentiometer (pot) P1 fully counter-clockwise (CCW), the DVM reading will be about 50mV less than step 1.
4. Connect a DVM set to measure AC between jumpers JP2-3 and JP2-4 (ground) of Store and Forward Repeater Logic Board.
5. Turn pot P2 on the Store and Forward Repeater Logic Board for a minimum reading (<70mV).
6. Remove the J5 Audio Generator source, and connect the Radio Receiver audio output to J5 pin 3 and pin 6 (ground) of the Store and Forward unit (Repeater Logic Board). Adjust the Radio Receiver audio output to a level between 200mV--500mV. For higher levels proceed with the next step.
7. Reconnect a DVM set to measure AC between jumpers JP2-1 and JP2-4 (ground) of the Store and Forward Repeater Logic Board. Adjust pot P3 clockwise (CW) for a reading between 400mV--500mV. (Minimum recommend for decoding = 10mV).

## STORE AND FORWARD AUDIO OUTPUT (TRANSMIT) SETUP

### RADIO 1 transmit audio output (not used) to transmitter adjustment:

1. Connect J4 pin 1 and pin 6 (ground) of the Store and Forward unit (Repeater Logic Board) to the transmitter audio input.
2. Connect a DVM set to measure AC between J4 pin 1 and pin 6 of the Store and Forward unit (Repeater Logic Board).
3. Adjust P5 on the Store and Forward Repeater Logic Board for a maximum audio out that will **not compress or overdrive** the transmitter modulator. The Radio Transmitter deviation must first be set per FCC requirements.

### RADIO 2 audio output to transmitter adjustment (required at time of radio installation):

1. Connect J5 pin 1 and pin 6 (ground) of the Store and Forward unit (Repeater Logic Board) to the transmitter audio input.
2. Connect a DVM set to measure AC between J5 pin 1 and pin 6 of the Store and Forward unit (Repeater Logic Board).
3. Adjust P6 on the Store and Forward Repeater Logic Board for a maximum audio out that will **not compress or overdrive** the transmitter modulator. The Radio Transmitter deviation must first be set per FCC requirements.

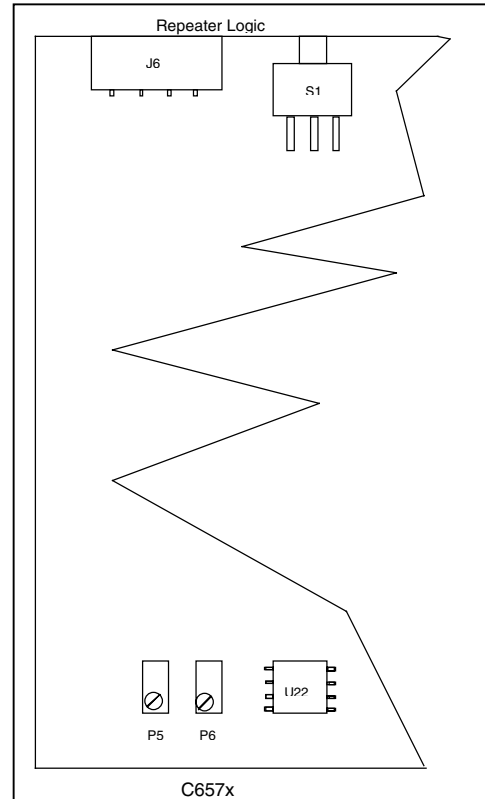

## STORE AND FORWARD UNIT INPUTS AND OUTPUTS

### J4 RADIO 1 (End-Units)

J4	FUNCTION	NOTES
1	Audio output, 2.5vac, 1k ohm	(Not used)
3	Audio input, 100mvac--1.5vac	Adjust P1
5	Open collector, 600mA max sink, PTT=ground	PTT=ground (Not used)
6	Ground	Common

### J5 RADIO 2 (Network)

J5	FUNCTION	NOTES
1	Audio output, 2.5vac, 1k ohm	Adjust P6
3	Audio input, 100mvac--1.5vac	Adjust P2
5	Open collector, 600mA max sink, PTT=ground	PTT=ground

6	Ground	Common
---	--------	--------

**Standard two-way radio installation procedures should be followed** for the installation of radio receivers and transmitters being used with the FastLink™ Store and Forward Network or system.

### III. PROGRAMMING

#### Programming

Programming of the FastLink™ Store and Forward unit is normally performed at Radionics based on the required parameters of the radio system installation. There are three methods of programming a FastLink™ Store and Forward unit.

#### 1. Through a PC

A direct connection between the FastLink™ Store and Forward unit's COM-2 port and a serial communication port of an IBM compatible computer.

#### 2. Through a Modem

2400 to 9600 bps modem via a telephone line to another modem connected to a serial communication port of an IBM compatible computer. The Modem at the Store and Forward unit must be programmed for "Auto Answer", and "Locked" to the COM-2 port's serial (baud) speed.

#### 3. Through a RF Link

A FastLink™ Store and Forward unit which is operational in a radio network can be programmed via a radio link from another FastLink™ Store and Forward unit. Method 1 or 2 above must be available via at least one Store and Forward unit location.

### IV. C6572, C6572S and C6573S FEATURES

#### Dynamic Event Display - LCD Display

The DYNAMIC EVENT DISPLAY/MENU, a Liquid Crystal Display (LCD) is used to display current events, and history memory. Also, programming menus, help screens and functions are displayed during program mode.

#### Displayed Messages

The standard message structure displayed by the C6572, C6572S and C6573S is as follows:

#### Liquid Crystal Display

06/28	19:38	1372,ALARM	ZONE 7
-------	-------	------------	--------

DATE TIME ACCT,MESSAGE ZONE

1. **DATE** and **TIME** of the received message.
2. **ACCT** is the account number programmed into the C601 End-Unit encoder.
3. **MESSAGE** is the event type reported by the C601 End-Unit encoder.

**Message Priority** (C6572, C6572S and C6573S only)

All received messages are saved to the **HISTORY** memory in the order received and will be maintained until a loss of power to the Store and Forward unit. The **HISTORY** memory stores up to 500 events and can be reviewed using the **MENU** display.

Messages are also displayed and annunciated on a first received basis in accordance with the following table. Messages are cleared from the display by pressing any of the front panel keys. Non-priority messages are automatically cleared by a priority message.

**Liquid Crystal Display Messages and Priority**

MESSAGE	PRIORITY, stay on top	BUZZER
ALARM ZONE #	Yes, until cleared	Beep, Beep (1 minute)
TROUBLE ZONE #	Yes, until cleared	Beep, Beep (1 minute)
RESTORAL ZONE #	No, canceled by higher priority	Beep, Beep
OPENING	No, canceled by higher priority	Beep, Beep
CLOSING	No, canceled by higher priority	Beep, Beep

**Priority Messages**

- ALARM ZONE 1-8 (Alarm Report)
- TROUBLE ZONE 1-8 (Trouble Report)
- TROUBLE ZONE 0 (AC Trouble)
- TROUBLE ZONE B (Phone Trouble)
- TROUBLE ZONE 9 (Low Battery)

**Non-Priority Messages**

- RESTORAL ZONE 1-8 (Restoral Report)
- RESTORAL ZONE 1-8 (Restoral Report)
- RESTORAL ZONE 0 (AC Restoral)
- RESTORAL ZONE B (Phone Restoral)
- RESTORAL ZONE 9 (Battery Restoral)
- RESTORAL ZN 9 (Power Up/Reset)
- OPENING REPORT (Opening)
- CLOSING REPORT (Closing)
- RESTORAL ZONE E (Test Report)

### Keypad Functions

In addition to canceling displayed alarm messages the front panel keys are used to toggle through the menu items while in program mode.

#### Front Panel Keypad Functions

KEY	FUNCTION
MENU	Enter menu mode
LEFT RIGHT SELECT	Scrolls left and right in menu mode
UP DOWN VALUE	Scrolls up and down in menu mode
ENTER	Enters blinking item in menu mode
EXIT	Exits selected menu item and menu mode
USER FUNCTION	Saves changed parameters in menu mode

#### Program Mode

1. To enter the main program mode menu press the MENU keys.
2. To select a sub-program menu press the LEFT / RIGHT keys until you reach the desired item and then press ENTER.
3. To select another program menu item repeated steps 1 and 2 until the desired parameter is reached then press ENTER and then USER FUNCTION as required.
4. Press EXIT as many times as required to escape to the main display.

***All parameter selections are displayed with a "Help Menu".***

## Menu Structure

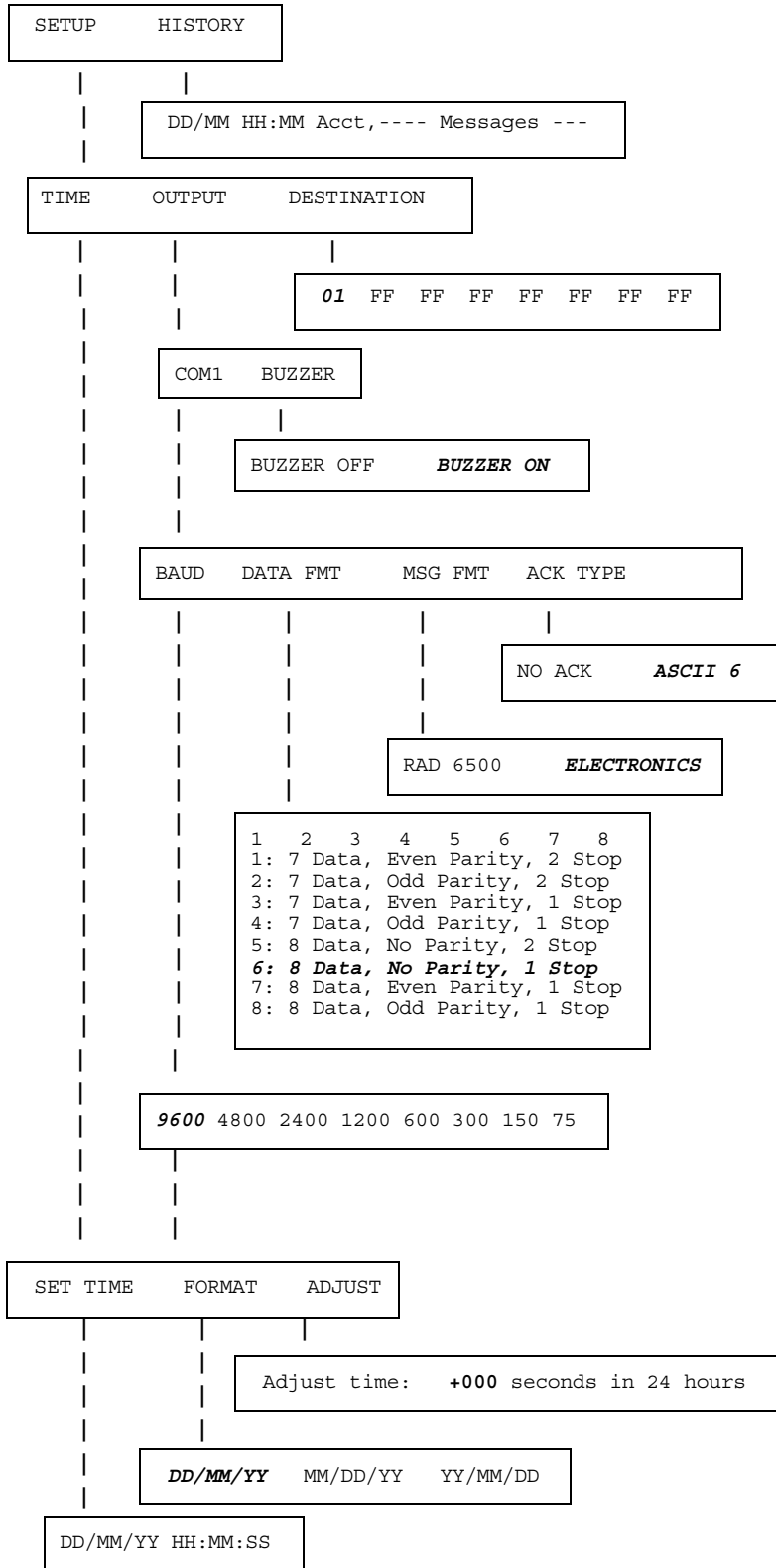

**BOLD** indicates defaults.

## Program Menu Options

**HISTORY** allows viewing of the 500 previously received messages. Use the UP / DOWN keys to move between them. When finished, press the EXIT key. The events are viewed showing the most recent event first.

**SETUP** allows programming of the C6572, C6572S, or C6573S parameters.

Setup menu: **TIME OUTPUT DESTINATION**

**TIME** allows setting the clock, choice of date format and adjustment of the clock's accuracy.

Time menu: **SET TIME FORMAT ADJUST**

**SET TIME** is always in the DD/MM/YY HH:MM:SS format. Use the UP / DOWN key to change the value and the LEFT / RIGHT keys to move. The UP / DOWN buttons in the "seconds mode" resets the value to zero.

**FORMAT** allows choice of display and print format of the date:

Date format menu: **DD/MM/YY** European

**MM/DD/YY** American

**YY/MM/DD** Japanese

**ADJUST** allows clock (time) accuracy adjustment per 24 hour period. Adjust the time offset direction by using the LEFT / RIGHT keys, LEFT for - and RIGHT for +. The UP/DOWN keys change the offset seconds.

### To set the adjusting offset:

1. Run the FastLink™ Store and Forward unit for a few days.
2. Determine the daily time error in seconds.
3. Set the offset parameter accordingly.
4. Re-check the accuracy and correct as required. The offset parameter is in seconds; therefore, an inaccuracy of up to half a second per day is possible.

**OUTPUT** allows you to set the COM1 RS232 output to the computer and the buzzer.

Output menu: **COM1 BUZZER**

**COM1** allows setting of the RS232 baud rate, byte length, parity, stop bits, data format and acknowledgment.

COM1 menu: **BAUD DATA FMT MSG FMT ACK TYPE**

**BAUD** allows selection of the baud rate (9600 is recommended):

**9600 4800 2400 1200 600 300 150 75**



**DATA FMT** allows selection of the following formats:

Data format menu: **1 2 3 4 5 6 7 8**

**Option 1: 7 Data, Even Parity, 2 Stop**

**Option 2: 7 Data, Odd Parity, 2 Stop**

**Option 3: 7 Data, Even Parity, 1 Stop**

**Option 4: 7 Data, Odd Parity, 1 Stop**

**Option 5: 8 Data, No Parity, 2 Stop**

**Option 6: 8 Data, No Parity, 1 Stop**

**Option 7: 8 Data, Even Parity, 1 Stop**

**Option 8: 8 Data, Odd Parity, 1 Stop**

***Set automation software if used to the same data format.***

**MSG FMT** selects message format:

Message format menu: **RAD D6500 ELECTRONICS**

**RAD D6500** (Radionics D6500) format. Set automation software if used to this format.

**ELECTRONICS** (Electronics Line TAL message) format.

**ACK TYPE** selects acknowledgment type:

Acknowledge menu: **NO ACK ASCII 6**

***The RS232 cable listed on page 14 should be used to control the data flow*** by the RTS and CTS signals if ASCII 6 is used.

**NO ACK** selects no acknowledgment required from the computer.

**ASCII 6** The FastLink™ Store and Forward unit waits for the Ack Character (ascii 6) after every message sent to the computer. Should the computer not return an Ack, the Store and Forward unit will wait 2.5 seconds and will re-send the same message again. This will continue until the computer “ACKS”. When browsing through the menus and an alarm message is being received, the Store and Forward unit will check the Ack state. If the computer acknowledges the messages then nothing will happen. Should the computer not acknowledge (or if the parameter is set to NO ACK), then the display will change to show incoming messages in accordance with priority/non-priority message protocol. In heavy traffic Central Stations it is almost impossible to change parameters when there are no computer acknowledgments.

It is recommended to use this parameter together with BUZZER ON. Thus, when the computer acknowledges the message, the Store and Forward unit beeps. If the computer doesn't acknowledge, the Store and Forward unit will sound two beeps on a Restoral event and beep for 1 minute on an Alarm event (until the ENTER key is pressed). This feature allows the operator to notice faults in the communication between the Store and Forward unit and the computer.

**BUZZER** selects annunciator function on receipt of a message.

Buzzer menu: **BUZZER OFF**      **BUZZER ON**

**BUZZER OFF** selects annunciator quiet when alarm messages are received.

**BUZZER ON** selects annunciator to sound, "beep". If the computer acknowledges the messages (see the ACK item above), the FastLink™ Store and Forward unit will beep. Should the computer not acknowledge, the Store and Forward unit will sound two beeps on a Restoral event and beep for 1 minute on an Alarm event (or until the operator presses the ENTER key).

**DESTINATION** (System ID number) The FastLink™ Store and Forward unit normally processes one System ID number, but in cases where one network handles several central stations (each with a different System ID number) it is useful to allow a C6572S Master Service Central Station Interface to recognize all the System ID numbers. The C6572S can be set to recognize up to 8 System ID numbers. To set the System ID, use the UP/DOWN keys to change the number and the LEFT/RIGHT keys to move between numbers. When finished press the ENTER key.

Default destination setting: **01 FF FF FF FF FF FF FF**

To disable destination (System ID) entry, set to FF.

***The C6572 uses two sets of identical parameters.*** One is stored in the non-volatile memory (EEPROM) and is used to initialize the second set which is stored in the volatile memory (RAM). The second set is the active parameter set. Whenever you change any of the parameters the active parameter is changed. When you press the ENTER key, the C6572S checks it against the non-volatile parameter. Should there be any changes the following will be displayed:

**New value is not saved ! Press USER FN. to save, EXIT to abort**

To update the non-volatile memory, press the USER FUNCTION key. To make a temporary change, press ENTER or EXIT. When you turn the power off and restart it, the last parameter set will be erased. The Store and Forward unit will be set to the parameters from the non-volatile memory.

#### **Exit (quit) Menu**

Press Exit as many times as required to return to the Main display.

#### **Printer Outputs**

A parallel printer (optional) can be connected to J3 - Printer output. Messages will be sent to the printer as received and printed in the following format:



## RS232 cable, FastLink™ Store and Forward COM-1 to PC

PC DB25 (F)	DB9 (F)	Store and Forward DB9 (F)
TxD 2	3	2 RxD
RxD 3	2	3 TxD
RTS 4	7	8 CTS
CTS 5	8	7 RTS
DSR 6	6	
DTR 20	4	
GND 7	5	5 GND

### Remarks:

1. The cable should be short (less than 30 feet).
2. For cables longer than 6 feet, shielded cable is recommended to avoid interference. The shielded should only be connected to the ground (GND) pin at the PC connector.
3. Use DB-9 and DB-25 female type connectors.

## V. DEFINITIONS

**Attenuator** is a passive calibrated electronic device used to decrease radio frequency signal and is normally used as test equipment.

**C6570** Store & Forward Controller. It receives messages from the protected premises sites and re-transmits them to the central station.

**C6571** Network Store & Forward Controller. It receives messages from the protected premises sites and also from other repeaters sites. It transmits messages to other repeater stations and also to the central station.

**C6571S** Service Store & Forward Controller. It receives messages from the protected premises sites and also from other repeaters sites. It transmits messages to other repeater stations and also to the central station.

**C6572** Network Central Station Interface. It controls and processes central station messages. Messages other than those intended for that particular central station will be rerouted.

**C6572S** Master Service Central Station Interface. It controls and processes central station messages. Messages other than those intended for that particular central station will be rerouted.

**C6573S** Central Station Interface. It controls and processes central station messages.

Messages other than for that particular central station will not be sent to the central station.

**DVM** (Digital Volt Meter or Digital Multi Meter) is an electronic test instrument used to measure basic electronic functions such as voltage, resistance. Some DVM's may also measure current, temperature, diodes, transistor, frequency, and logic levels.

**End-Unit** Equipment installed at the protected premises for the purpose of encoding and transmitting alarm messages, i.e., the C601 Encoder, the C472TX/TP Transmitter and an antenna.

**"F1" Frequency** A label given a radio frequency. Normally used to signify the protected premises transmit frequency, also called the "uplink" frequency.

**"F2" Frequency** A label given a radio frequency. Normally used to signify the repeater to central station frequency, also called the "downlink" frequency, used by the repeater stations to transmit messages to the central station. Also, used to signify the network frequency, used between repeaters.

**"F3" Frequency** A label given a radio frequency. Normally used to signify a third frequency in a radio system.

**Margin Test** A test where a R.F. Attenuator is inserted in the transmit or receive line to reduce the amount of signal. The purpose of the test is to prove the successful operation of the system under R.F. signal loss conditions. Radionics' minimal recommended margin is 10dB.

**Protected Premises** A physical site employing security electronic devices for the purpose of safety against intrusion and fire.

**R.F. or Radio Frequency** Electromagnetic energy produced by a rapidly changing electrical current which travels at the speed of light.

**Radio Receiver** An electronic device used to gather and convert radio signals into audio or other useable data.

**Radio Repeater** An electronic device consisting of both a radio receiver and radio transmitter capable of simultaneous operation in both modes. Normally used to receive and re-transmit radio signals.

**Radio Transceiver** An electronic device consisting of both a radio receiver and radio transmitter which operates in only one of the two modes at any given time.

**Radio Transmitter** An electronic device which converts audio or data into radio frequency signals for the purpose broadcasting (transmitting) to a radio receiver.

**Wattmeter** is an electronic test instrument use to measure R.F. power.

## VI. TROUBLESHOOTING and SPECIFICATIONS

### Troubleshooting

FastLink™ Store and Forward unit troubleshooting requires minimal tools such as a Digital Volt Meter (DVM), R.F. Attenuator and R.F. Watmeter. Problems can be isolated to a group such as End-Unit(s), Store and Forward unit(s), Central Station equipment, radio equipment, and radio propagation factors.

The FastLink™ Store and Forward unit's **LED PANEL** can be referenced for proper operational status. Account 8000 messages if any, are indications of possible radio communications problems. Radio problem resolution may also require the services of a two-way radio service shop. For End-Unit problems refer to the respective end-user equipment Operation and Installation manual(s).

### Above Account 8000

Messages with account numbers above 8000 can be generated by FastLink™ Store and Forward units. 800x message reporting is a Store and Forward programmable option, that when enabled is used to monitor the loss and restoral of the data communications path from another Store and Forward. Each Store and Forward unit site can be assigned an Account 80xx number and Zone number which is used to identify that site. Each Store and Forward unit site can also be assigned the task of monitoring (listening) up to sixteen Store and Forward sites. When monitoring is active, a loss or restoral of communications data will cause the Store and Forward unit site(s) to generate a report indicating the problem site and the reporting site.

1. **Account 80xx**, is the site with which communications was lost or restored. This can be a problem with the reported site not transmitting data or the receiving site not receiving data.
2. **Trouble**, indicates that communications was lost.
3. **Restoral**, indicated that communications was re-established.
4. **Zone xx**, is the site reporting the problem.

### Example #1

**ACCT 8004 Trouble Zone 5** Loss of data path from site 8004 (site 4) is being reported by site 5.

Probable Cause: site 4 has a transmitting problem, or site 5 has a receiving problem.

### Report example #2

**ACCT 8001 Trouble Zone 3** Loss of data path from site 8001 (site 1) is being reported by site 3.

**ACCT 8004 Trouble Zone 3** Loss of data path from site 8004 (site 4) is being reported by site 3.

**ACCT 8005 Trouble Zone 3** Loss of data path from site 8005 (site 5) is being reported by site 3.

Probable Cause: site 3 has a receiving problem, e.g., receiving antenna system, radio receiver, or radio to Store and Forward connection missing.

### Report Example #3

**ACCT 8001 Restoral Zone 3** Restoral of data path from site 8001(site 1) is being reported by site 3.

**ACCT 8004 Restoral Zone 3** Restoral of data path from site 8004 (site 4) is being reported by site 3.

**ACCT 8005 Restoral Zone 3** Restoral of data path from site 8005 (site 5) is being reported by site 3.

Probable cause: system is back to normal.

### Report Example #4

**ACCT 8007 Trouble Zone 1** Loss of data path from site 8007 (site 7) is being reported by site 1.

**ACCT 8007 Trouble Zone 5** Loss of data path from site 8007 (site 4) is being reported by site5.

**ACCT 8007 Trouble Zone 8** Loss of data path from site 8007 (site 4) is being reported by site 8.

**Probable Cause:** site 7 has a transmitting problem, e.g., transmitting antenna system, radio transmitter, or radio to Store and Forward connection missing.

**Troubleshooting Chart** (programming will affect LED's 7, 8, 9, 10, and 12)

<b>SYMPTOM</b>	<b>CHECK</b>	<b>PROBABLE CAUSE</b>
LED(s) 12, 13, 14, 15 incorrect.	Power supply output, +12.5Vdc to +14.0Vdc, $\leq 20\text{mVac}$ . Power supply input, AC voltage per manufacturer.	Power supply bad. AC voltage input to power supply low.
LED 13, 14, or both "OFF". LED 15 = "ON"	Re-check power.	Store and Forward unit defective.
LED 12 = "ON".	Program, contact Radionics	Wrong programming.
LED 11 = "OFF"	Re-check power.	Store and Forward unit defective.
Cannot change programming via COM-2.	Power supply output.	Voltage too low.
	Computer cable.	Wrong or defective.
	JP11 jumper (recommended 9600 baud)	Wrong setting or missing.
No system messages via COM-2.	C6570/C6571/C6571S J1 pins 2 and 3 should be jumpered.	Not connected.
	C6572/C6572S/C6573S	% not programmed.
Too many repeats of messages on COM-2.	C6570/C6571/C6571S J1 pins 7 and 8 should be jumpered.	Not connected.
	C6572/C6573S "ACK" programming.	Wrong "ACK" programmed.
No system messages via COM-1.	Computer cable.	Wrong or defective.
	JP5 jumper (recommended 9600 baud)	Wrong setting or missing.
Messages garbled via COM-1, COM-2, or both.	JP11, JP5 jumper settings.	Wrong baud setting.
LED 7, 9, or both not flashing.	RADIO-2, RADIO-1, or both.	Power off. No or low receive audio.
	Receiver antenna system.	Antenna system not connected or defective. Radio defective.
LED 8 does not flash.	Programming, contact Radionics.	Wrong programming.



LED 8 flashes, but long intervals.	Programming, contact Radionics.	Wrong programming.
	Receiver audio.	Audio low, noisy, or distorted. R.F. interference.
LED 8 flashes, but "NO" transmit.	Radio transmitter.	Radio power off. No or low transmit audio. Radio defective.
	Transmitter antenna system.	No or low power output. Antenna system not connected or defective.
LED 8, or 10 = always "ON".	Re-check power.	Store and Forward unit defective.
LED 10 = always "OFF".	(not used).	(not used).
LED 5 and 6 = "ON"	JP5 and J11 jumpers.	Missing or defective jumper.
Missing End-Units, network = OK	LED 9	Network Radio Receiver
		End-unit equipment.
Missing End-Units.	LED 9	RADIO-1 receiver
	LED 7	End-unit equipment.
	LED 8	RADIO-2 receiver. RADIO-2 transmitter.
Account 8001 and above "Trouble" and "Restoral" messages.	LED 7	RADIO-2 receiver(s).
	LED 8	RADIO-2 transmitter(s).
Transmitter stays "KEYED ON"	LED 8	Defective Store and Forward unit.
		Shorted PTT line.
		Defective transmitter.

## Specifications

<b>Model</b>	C6570/C6571/C6571S/C6572/C6572S/C6573S
<b>Operating Temperature</b> 70° C	0 -
<b>Dimensions</b>	3.5"h x 16.5w x 8.3d" (C6570/C6571/C6571S, 1.75"h)
<b>Mounting</b> rack	Standard 19 inch
<b>Weight</b>	7.5 lb
<b>Operating Voltage</b>	(10.2 - 14.5) volt DC
<b>Programming Voltage</b>	(13.5 - 14.5) volt DC
<b>External Power Supply required</b>	(13.6 - 14.0) volt DC
<b>Nominal Current</b>	800 mA @ 13.6vDC
<b>Push-to-Talk Output</b> collector)	High to low (open
<b>Receive Audio Input</b> adjustable	10 mVrms to 3 Vrms,
<b>Transmit Audio Output</b>	0 V to 5 Vpp, adjustable